

## E3WR

LED Linear Wraplight Fixture  
2-ft & 4-ft options • 10-yr Warranty

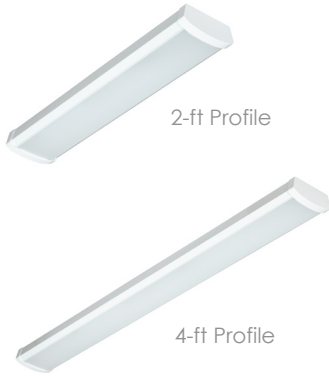

## OVERVIEW

Energetic Lighting's E3WR series of LED surface mount wraps showcase a simple yet elegant fixture form factor while delivering up to 4680 lumens in either a 2-ft or 4-ft length profile, while drawing only 20 and 40 watts of power, respectively. Dimmable with standard 0-10v dc low voltage systems. These versatile lights can be used for general room lighting, or as functional work area lights with an all-white appearance. Installation is quick and simple when mounting into standard ceiling junction boxes where access to interior wiring compartment only involves removing the front diffuser using an included suction cup tool.

A simple housing core design uses less material for weight reduction, yet maintaining a durable steel body to retain a rugged overall construction. These versatile wrap light fixtures can be used in just about any type of installation location including, hallways, offices, schools, hospitals, and commercial warehouses.

## KEY FEATURES

- Available in either 3500K, 4000K, 5000K CCT
- Two housing profiles in either 2-ft or 4-ft lengths
- 3 available standard 1/2-inch trade-sized knockouts available on the back of the fixture housing
- Suitable for dry or damp location installations
- Easy wiring compartment access using the supplied suction cup tool
- Pass-through single-wall wiring with integrated wire hold-down points provide easy and quick wiring as well as clean wire routing within the interior compartment
- Dimmable with standard 0-10v low voltage DC systems
- Minimum 92% lumen maintenance @ 36,000 hours – L92/36,000 (per IES TM21)
- Minimum projected L70 @ 161,000 hours = maintenance free illumination (per IES TM21)

## Highlights

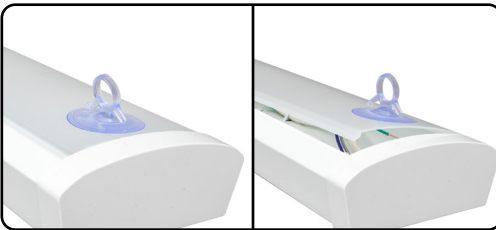

Easy access into wiring compartment by removing the front diffuser lens using the included suction cup tool.



Integrated metal wire hold-down points keep internal wiring neat and away from LED array

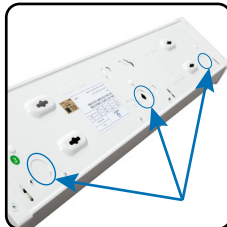

Three 1/2-inch trade-size knockouts are provided on the back plate to accommodate different mounting options

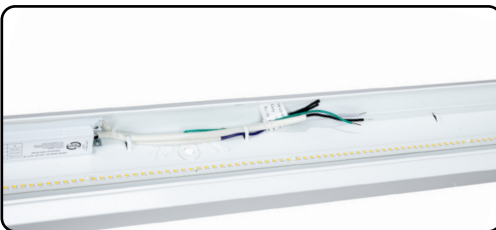

Open interior compartment allows for easy wire routing and quick installation time

## Load Information

<b>Input Voltage</b>	120-277Vac	
<b>Power Factor</b>	0.9	
<b>THD</b>	10%	
<b>Low Temp Start</b>	-20°C (-4°F)	
<b>Max Temp</b>	50°C (122°F)	
<b>Unit Weight</b>	2-ft profile	3.0 LBS
	4-ft profile	5.0 LBS

## Shipping Information

Item	Weight	Box Qty.
2-ft profile	12 lbs	4 per
4-ft profile	22 lbs	4 per

## Lumen Maintenance

Ambient Temp	TM-21 Lumen Maint. (36,000 hours)	Theoretical L70 (hours)
25°C	>92%	161,000

## Dimensions

### 2-FT Length Profile

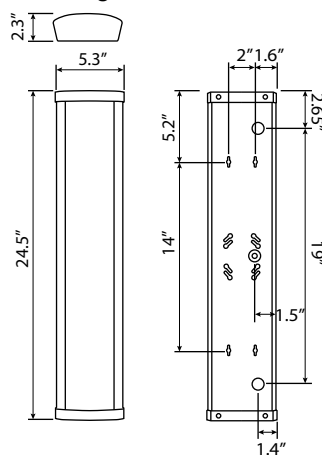

### 4-FT Length Profile

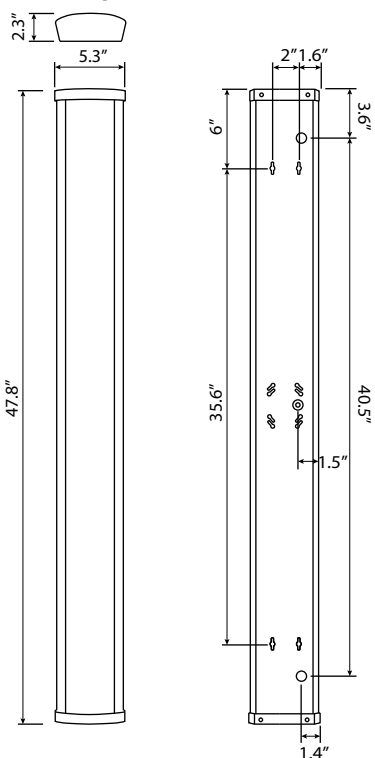



**STOCK ORDERING INFORMATION**

**2-FT Length Profile**

Catalog Logic	Order #	Lumens	Wattage	LPW	Color Temperature	CRI	Voltage	Dimming	DLC	Pallet Qty
E3WR20D2-835	30122	2280 LM	20 W	114	3500K	82	120-277	0-10v	DLC5.1-S	312
E3WR20D2-840	30123	2300 LM	20 W	115	4000K	82	120-277	0-10v	DLC5.1-S	312
E3WR20D2-850	30124	2320 LM	20 W	116	5000K	82	120-277	0-10v	DLC5.1-S	312

**4-FT Length Profile**

Catalog Logic	Order #	Lumens	Wattage	LPW	Color Temperature	CRI	Voltage	Dimming	DLC	Pallet Qty
E3WR40D4-835	30125	4600 LM	40 W	115	3500K	82	120-277	0-10v	DLC5.0-S	192
E3WR40D4-840	30126	4640 LM	40 W	116	4000K	82	120-277	0-10v	DLC5.0-S	192
E3WR40D4-850	30127	4680 LM	40 W	117	5000K	82	120-277	0-10v	DLC5.0-S	192

**PHOTOMETRIC DATA**

Cat Logic: E3WR20D2-840\*  
Applicable: E3WR20D2-835  
Models: E3WR20D2-850  
Test Report: E3WR20D2-840.IES  
CCT: 4000K  
Lamp Type: LED  
Lumens: 2314 LM  
Input Watts: 20.2 W  
Efficacy: 115 LM/W  
Spacing Criteria: [0° : 1.20] [90° : 1.18]

**Polar Candela Plot**

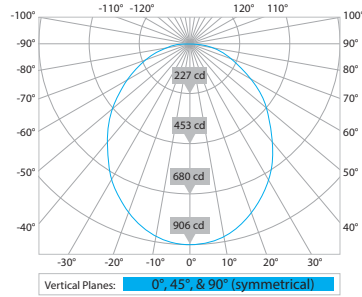

**Zonal Lumen Summary**

Zone	Lumens	%Luminaire
0-20	325.89	14.1
0-30	678.99	29.3
0-40	1086.79	47
0-60	1839.98	79.5
0-80	2248.82	97.2
0-90	2301.72	99.5
0-180	2313.9	100

**Coefficients of Utilization**

Effective Floor Cavity Reflectance 0.20

rc	80%				70%				50%			30%			10%			0%
	rw	50	30	10	70	50	30	10	50	30	10	50	30	10	50	30	10	0
RCR																		
0	119	119	119	119	116	116	116	116	111	111	111	106	106	106	102	102	102	99
1	109	104	100	96	106	102	98	94	97	94	91	93	91	88	90	87	86	83
2	99	91	84	78	96	89	83	78	85	80	76	82	78	74	79	75	72	70
3	91	80	72	66	88	78	71	65	75	69	64	73	67	63	70	65	61	59
4	83	71	63	56	81	70	62	55	67	60	55	65	59	54	63	57	53	51
5	76	64	55	48	74	63	54	48	60	53	48	58	52	47	57	51	46	44
6	71	58	49	42	69	57	48	42	55	47	42	53	46	41	51	46	41	39
7	66	52	44	38	64	52	43	37	50	43	37	48	42	37	47	41	37	35
8	61	48	39	34	60	47	39	34	46	39	33	44	38	33	43	37	33	31
9	57	44	36	30	56	43	36	30	42	35	30	41	35	30	40	34	30	28
10	54	41	33	28	52	40	33	28	39	32	27	38	32	27	37	31	27	25

\* NOTE: Data produced from 4000K CCT setting where:  
- 3500K values can be estimated by decreasing of 0.991 factor from 4000K  
- 5000K values can be estimated by increasing by a factor of 1.008 from 4000K

**Isofootcandle Sampling**

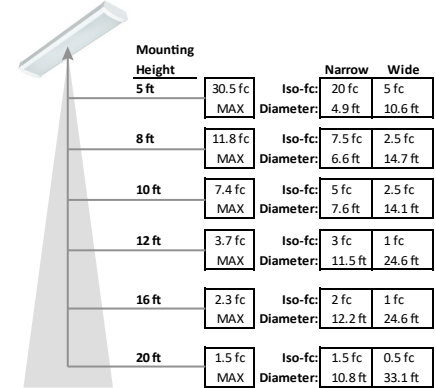

**PHOTOMETRIC DATA**

Cat Logic: E3WR40D4-840\*  
Applicable: E3WR40D4-835  
Models: E3WR40D4-850  
Test Report: E3WR40D4-840.IES  
CCT: 4000K  
Lamp Type: LED  
Lumens: 4587 LM  
Input Watts: 38.46 W  
Efficacy: 119 LM/W  
Spacing Criteria: [0° : 1.20] [90° : 1.16]

**Polar Candela Plot**

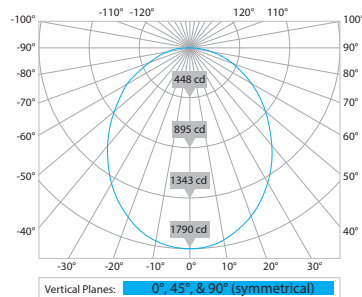

**Zonal Lumen Summary**

Zone	Lumens	%Luminaire
0-20	643.55	14
0-30	1340.73	29.2
0-40	2146.58	46.8
0-60	3639.93	79.3
0-80	4450.08	97
0-90	4549.49	99.2
0-180	4587.43	100

**Coefficients of Utilization**

Effective Floor Cavity Reflectance 0.20

rc	80%				70%				50%			30%			10%			0%
	rw	50	30	10	70	50	30	10	50	30	10	50	30	10	50	30	10	0
RCR																		
0	119	119	119	119	116	116	116	116	111	111	111	106	106	106	101	101	101	99
1	109	104	100	96	106	102	98	94	97	94	91	93	91	88	89	87	85	83
2	99	91	84	79	96	89	83	77	85	80	76	82	78	74	79	75	72	70
3	90	80	72	66	88	78	71	65	75	69	64	72	67	63	70	65	61	59
4	83	71	63	56	81	70	62	55	67	60	55	65	59	54	63	57	53	51
5	76	64	55	48	74	63	54	48	60	53	47	58	52	47	56	51	46	44
6	71	58	49	42	69	57	48	42	55	47	42	53	46	41	51	45	41	39
7	66	52	44	38	64	51	43	37	50	42	37	48	42	37	47	41	36	34
8	61	48	39	34	60	47	39	34	46	38	33	44	38	33	43	37	33	31
9	57	44	36	30	56	43	36	30	42	35	30	41	35	30	40	34	30	28
10	54	41	33	28	52	40	33	28	39	32	27	38	32	27	37	31	27	25

\* NOTE: Data produced from 4000K CCT setting where:  
- 3500K values can be estimated by decreasing of 0.991 factor from 4000K  
- 5000K values can be estimated by increasing by a factor of 1.008 from 4000K

**Isofootcandle Sampling**

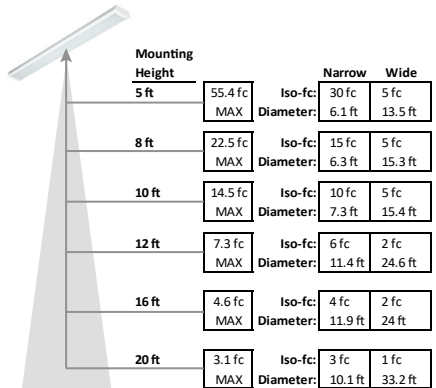



**ENERGETIC**  
L I G H T I N G

**E3WR**

LED Linear Wraplight Fixture  
36,000 System Lifetime • 10-yr Warranty

**NOTES:**

Empty rectangular box for notes.



**NOTES:**

Empty rectangular box for notes.